

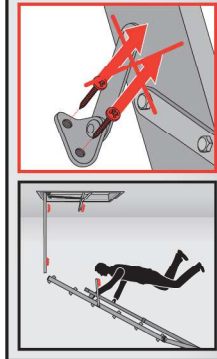

# WARNING! - ACHTUNG! - UWAGA! - ATTENTION! - CUIDADO! - ВНИМАНИЕ!

NC 9JX KB2729

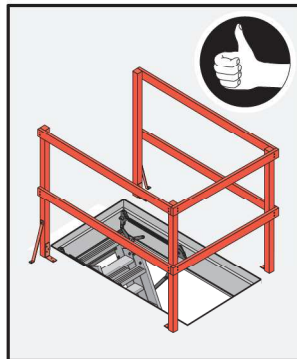
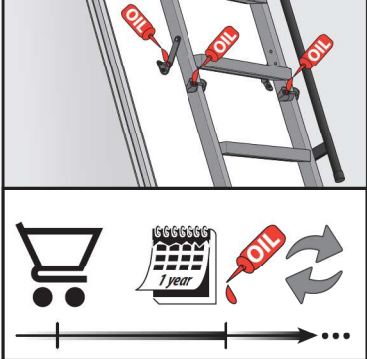
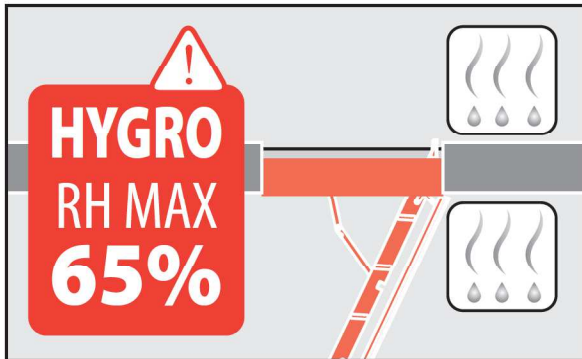
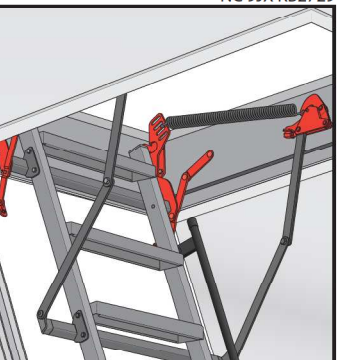
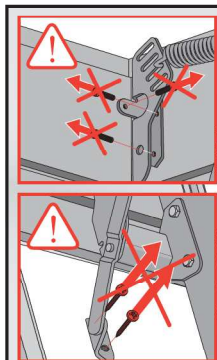
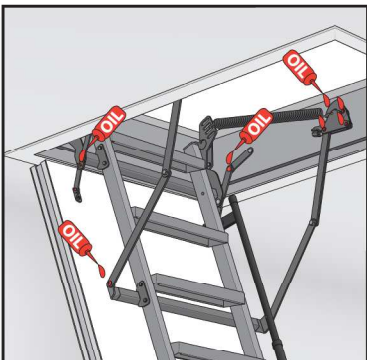
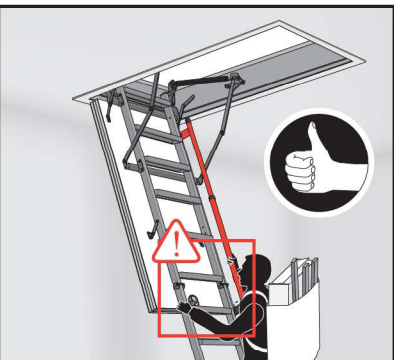
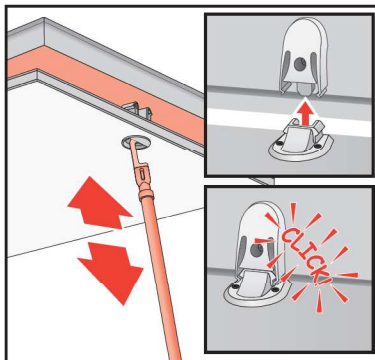

**FAKRO**  
www.fakro.com

\*European Standard EN14975  
\*\* internal tests according to ANSI 14.9-2004

**SAFETY! - SICHERHEIT! - BEZPIECZEŃSTWO!  
SÉCURITÉ! - SEGURIDAD! - БЕЗОПАСНОСТЬ!**  
<http://www.fakro.com/download/safety-instructions/loft-ladders.php>

